

1 m 3.3'

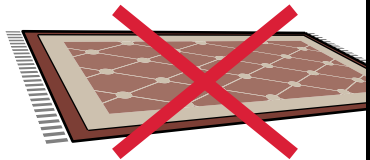

$\leq 1 \text{ mm } 3/64''$

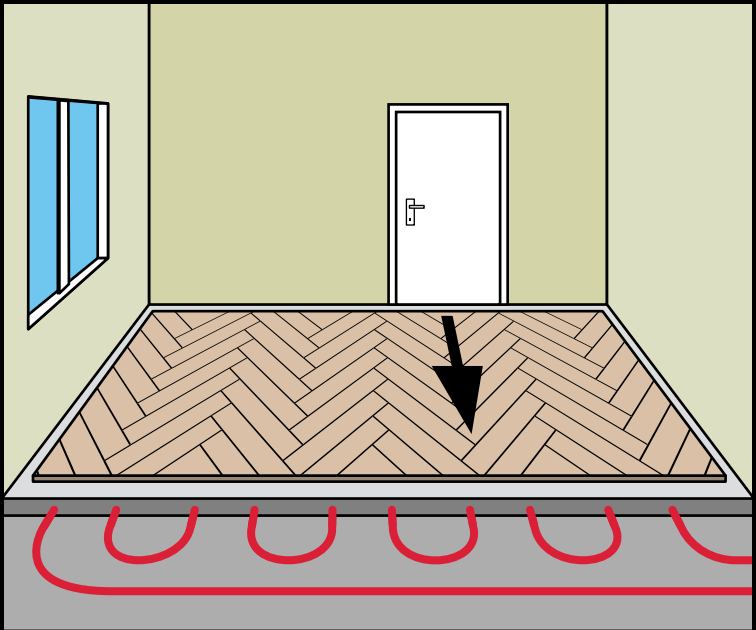



H₂O



AC/DC

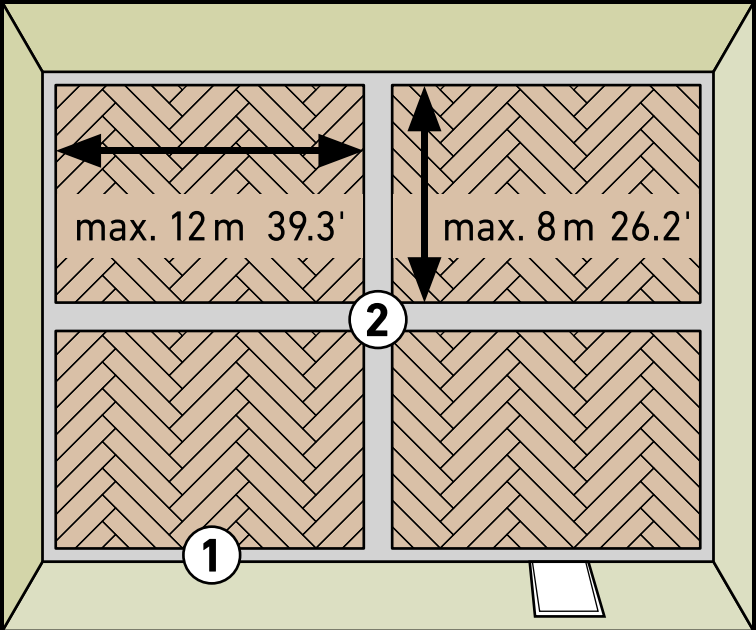

① 10 mm 25/64"

② 20 mm 25/32"

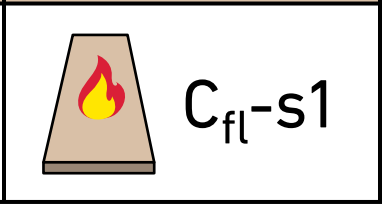
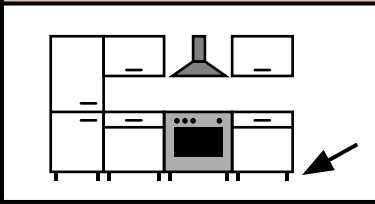
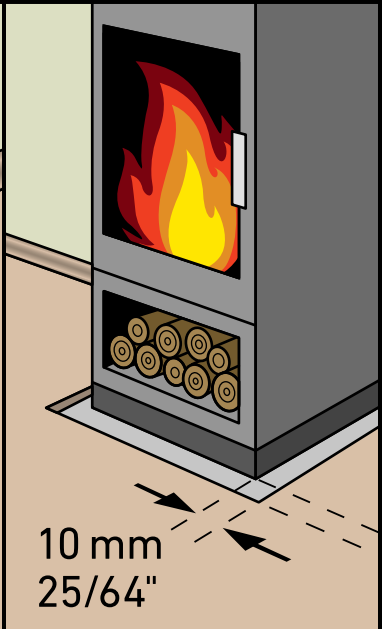
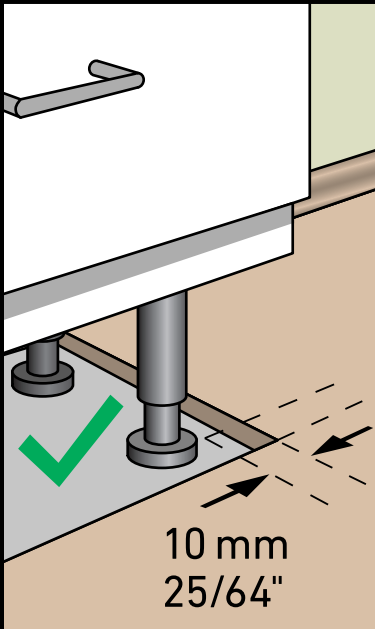

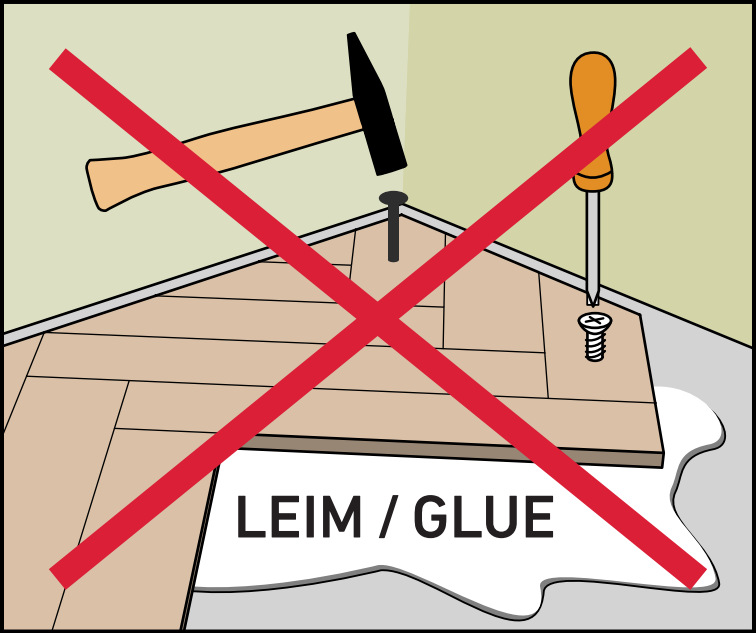

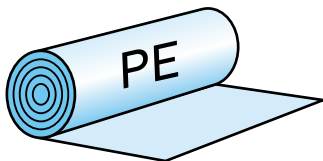
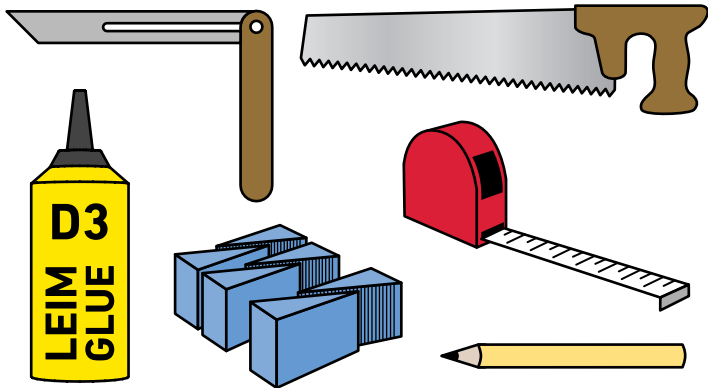

0,2 mm
 1/64"



1–3 mm
 3/64" –
 13/64"

 $\geq 12 \text{ t/m}^2$
 120 kPa



HERRINGBONE

HERRINGBONE

HERRINGBONE

HERRINGBONE

100% KLEBER
KLEBER
KLEBER
KLEBER



A B

HERRINGBONE

100% KLEBER
KLEBER
KLEBER
KLEBER



A B

A B

A B



30 mm
1-3/16"

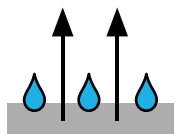
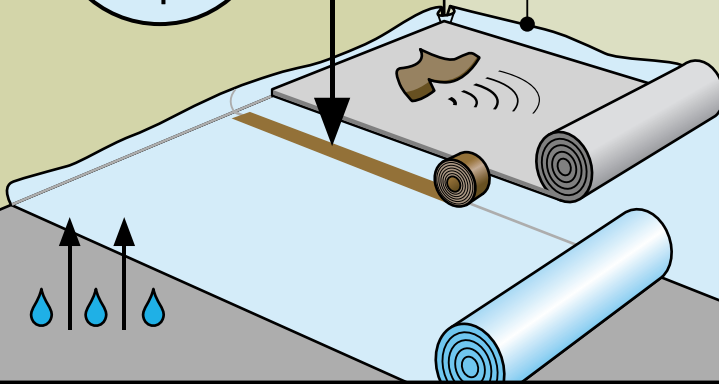

CA max. 0,5 CM%



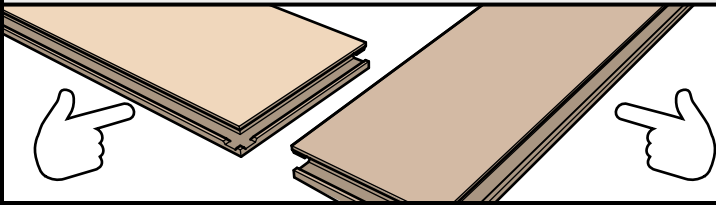
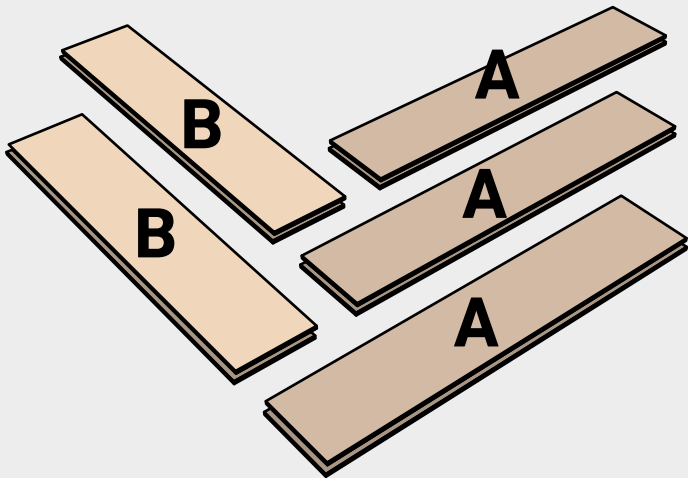

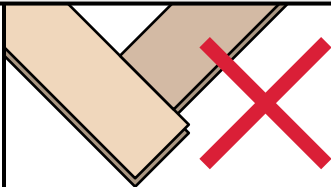
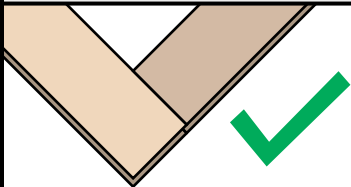
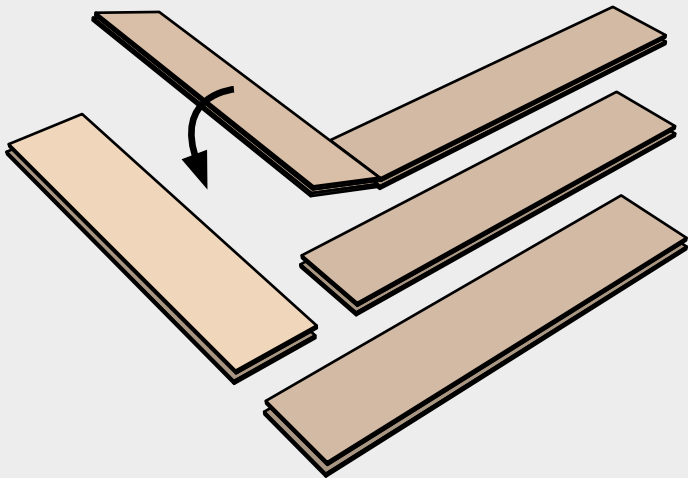

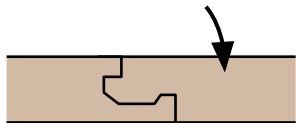
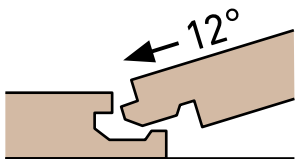
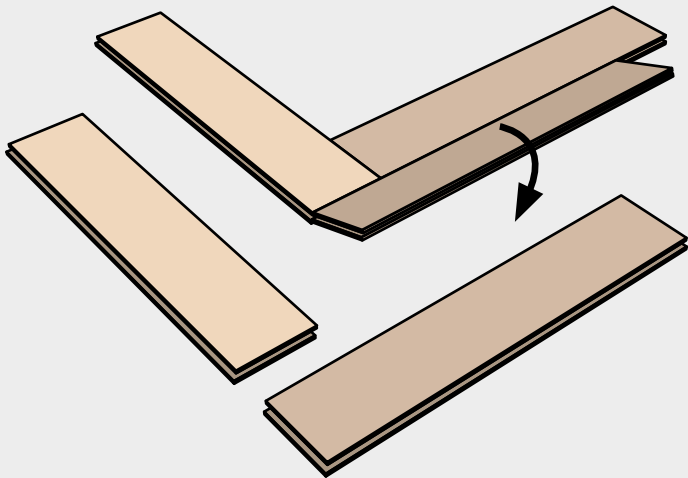

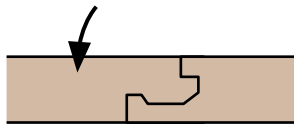
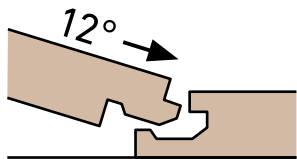
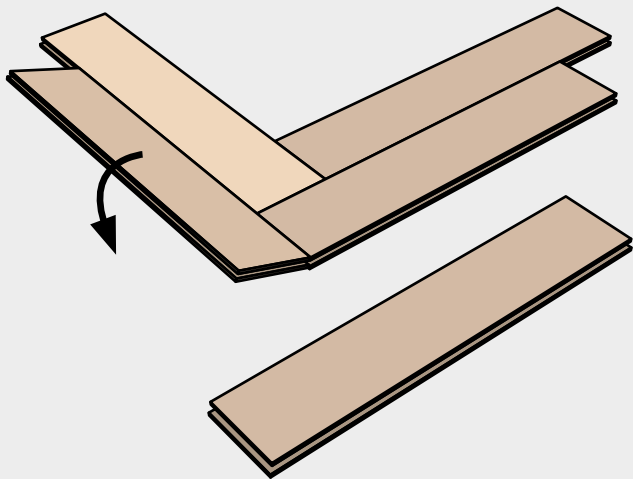

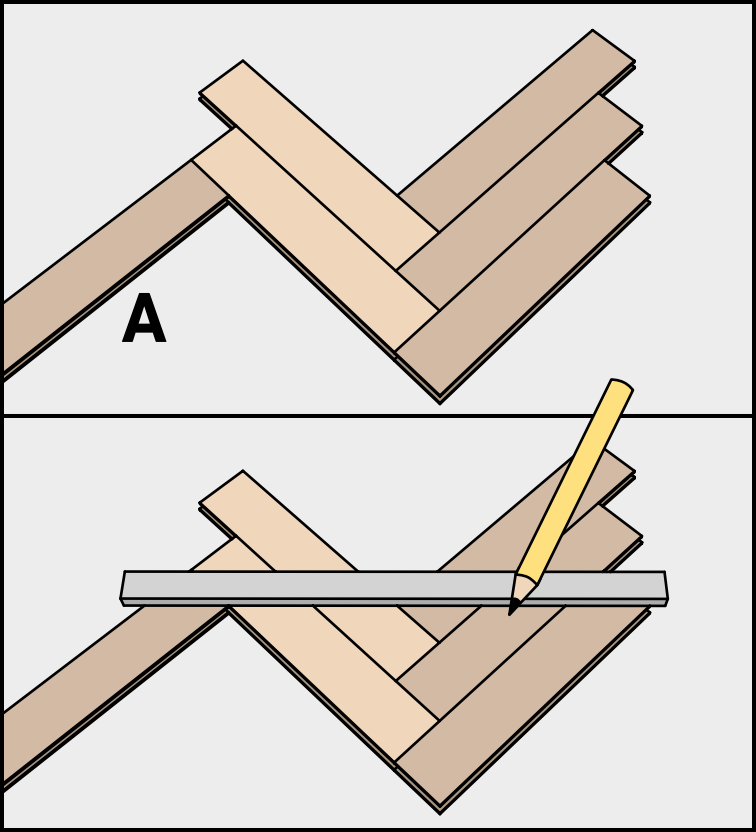

A

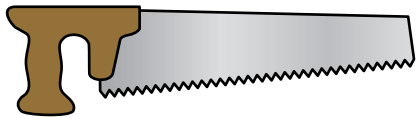
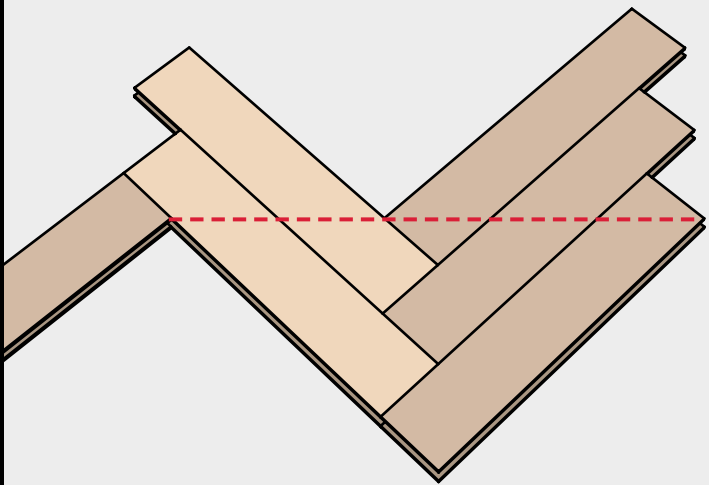

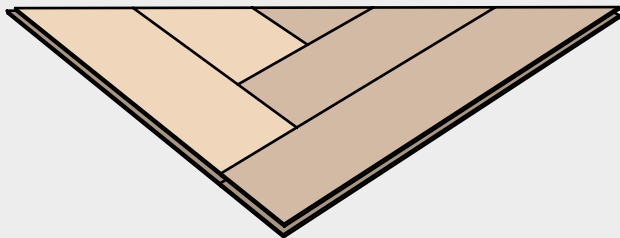
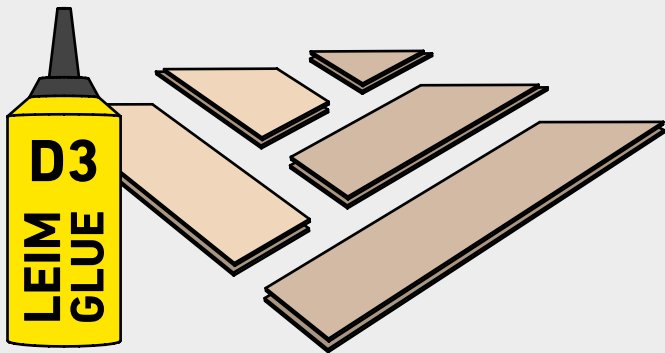

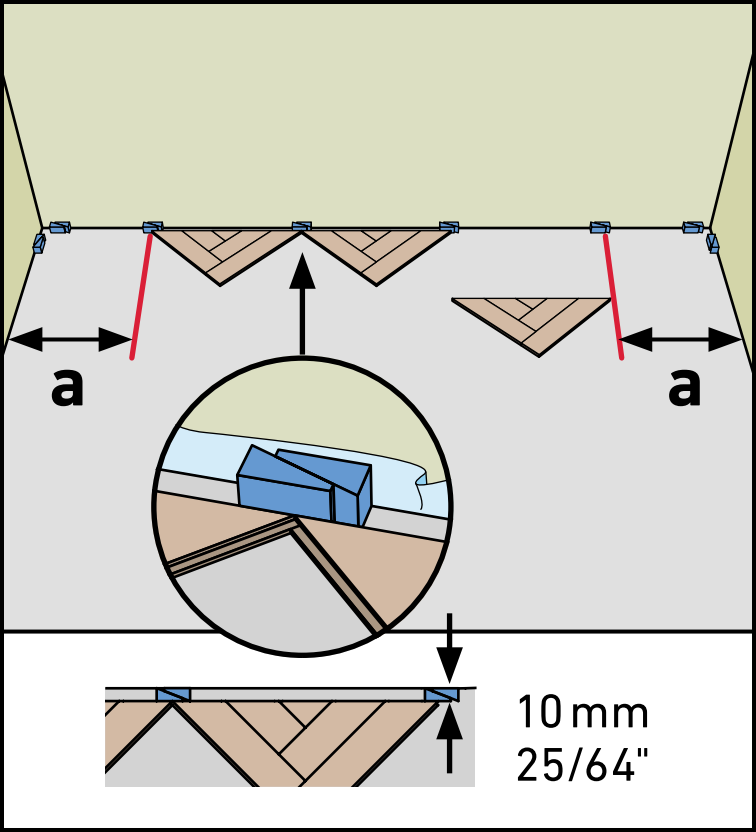

10 mm
25/64"

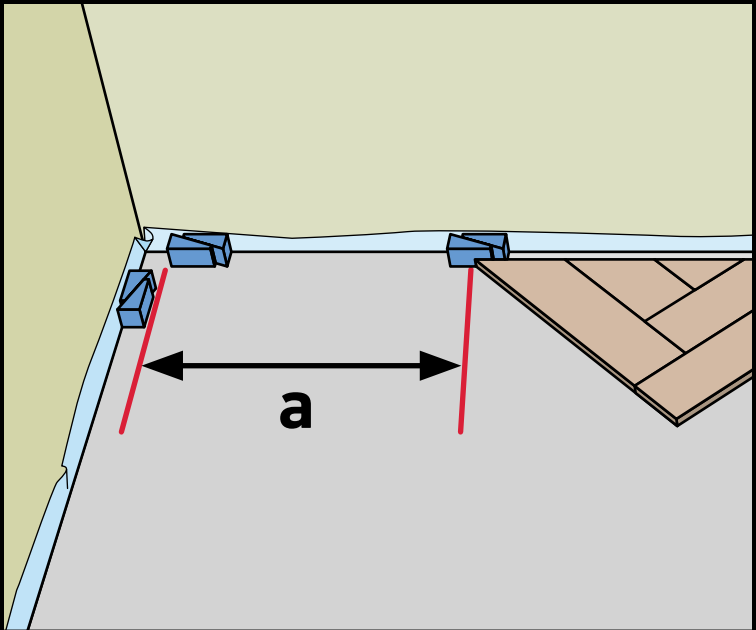

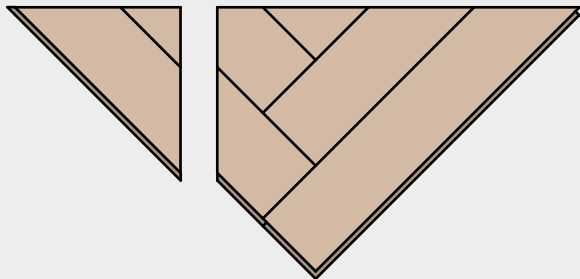
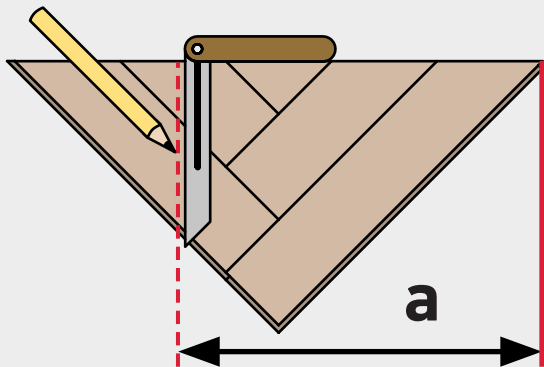

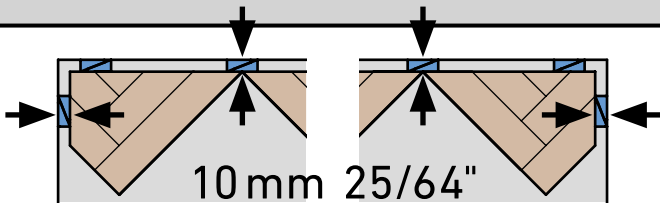
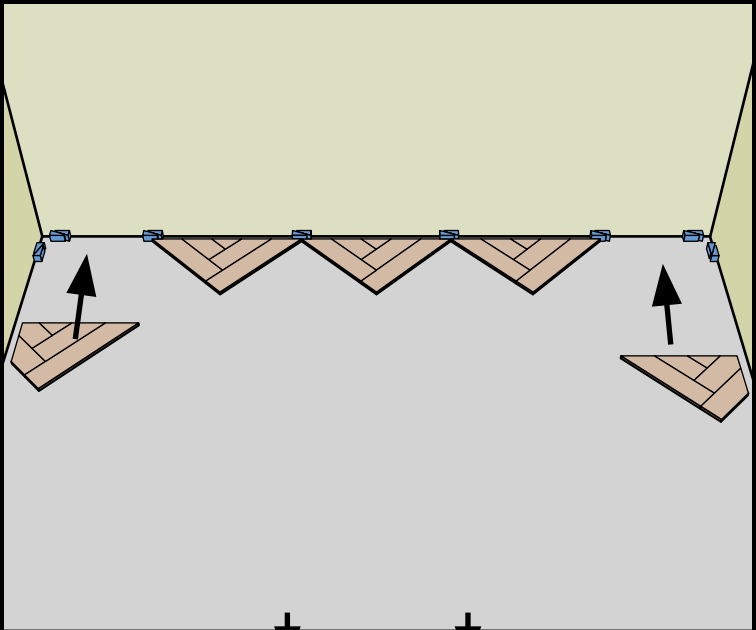

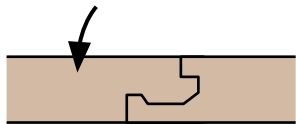
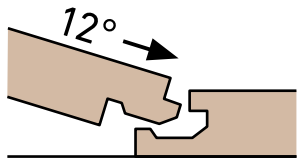
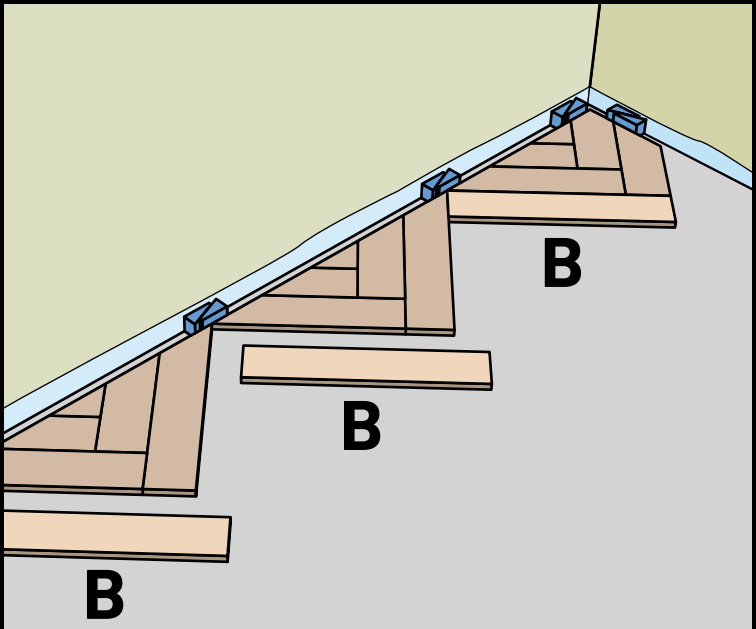

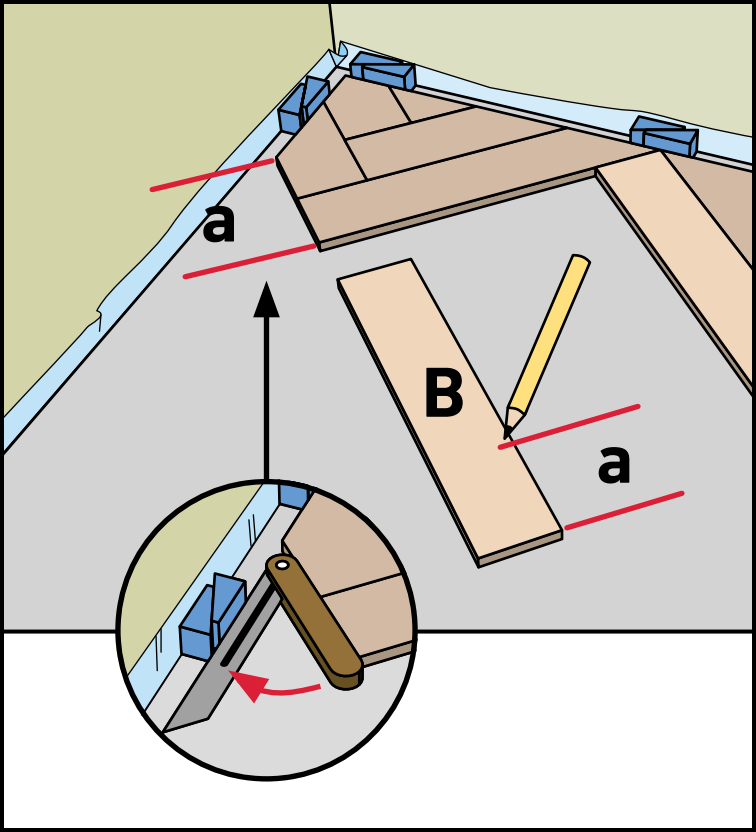

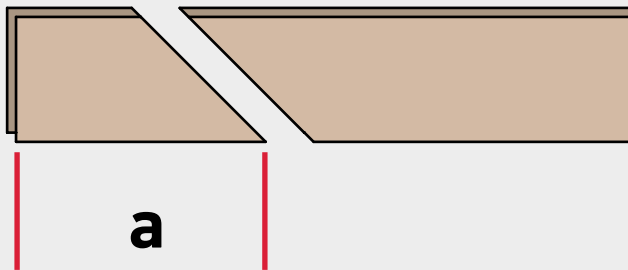
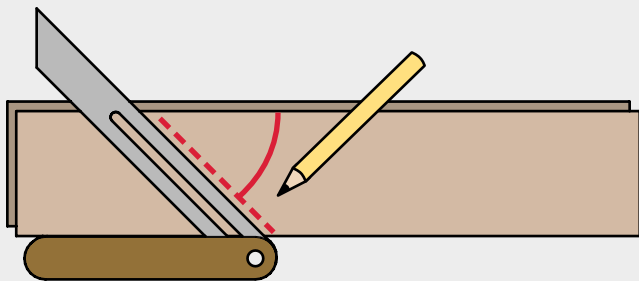

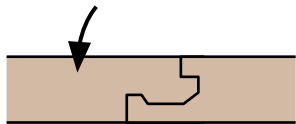
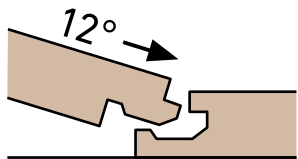
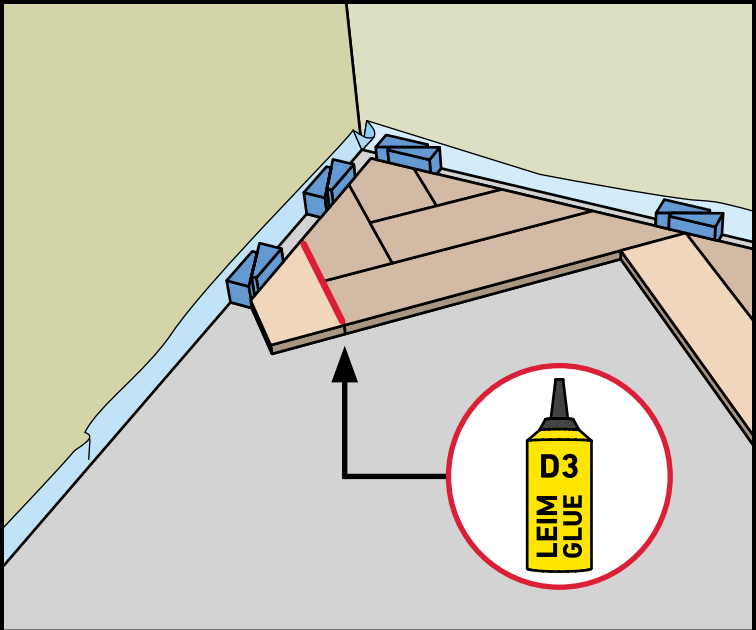

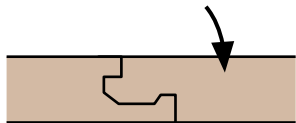
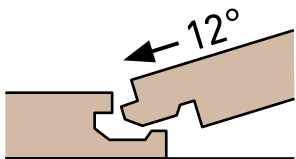
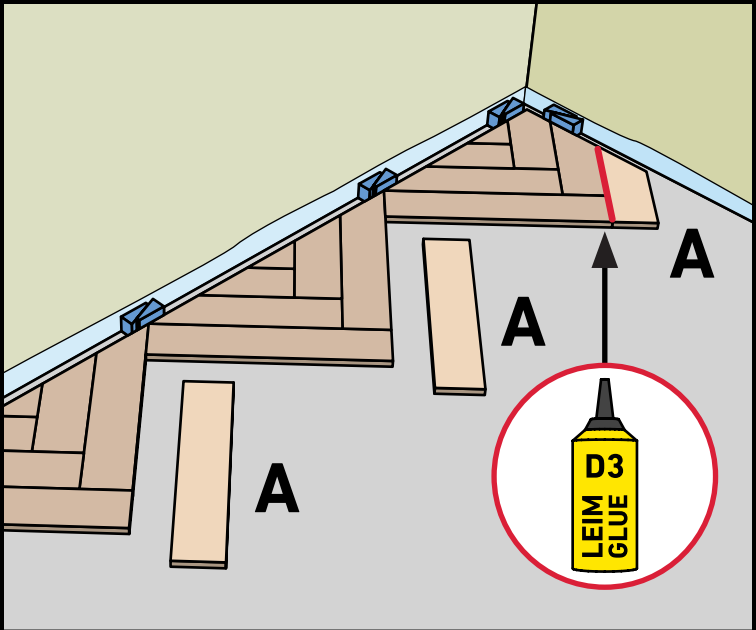

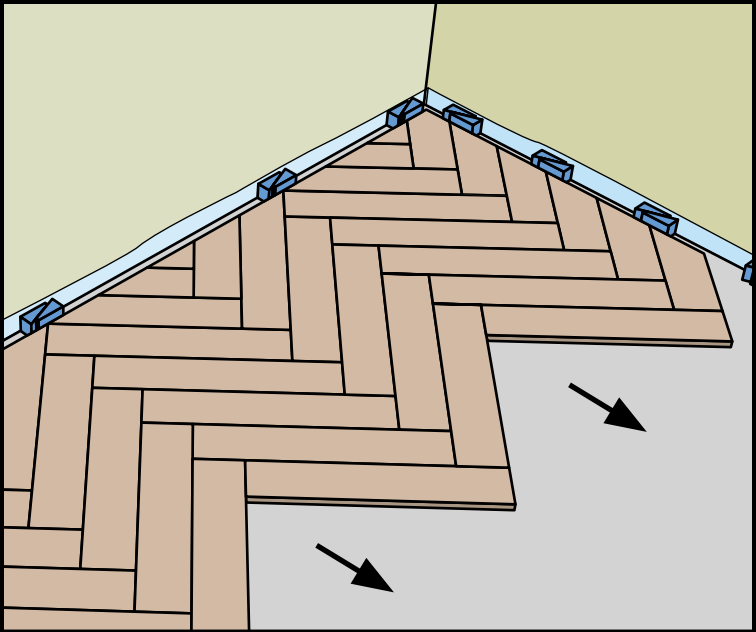

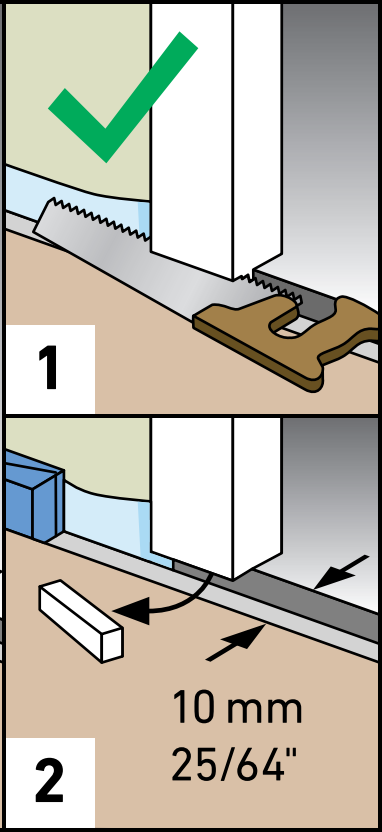
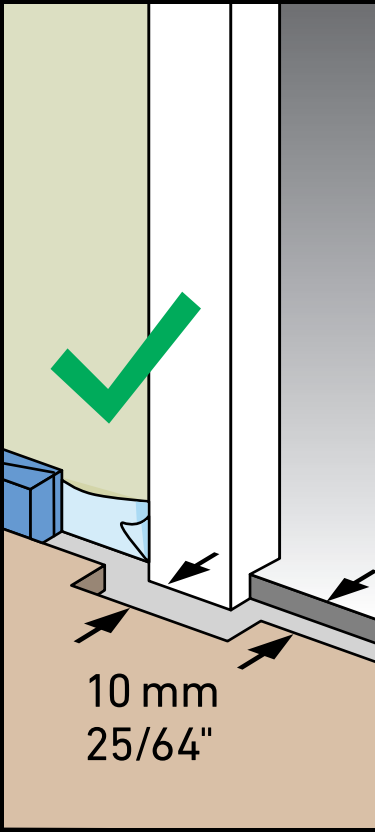

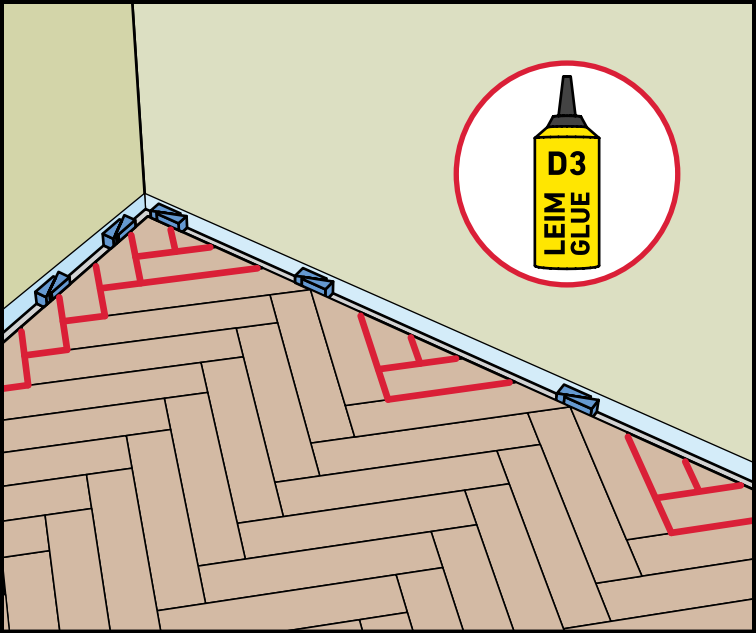

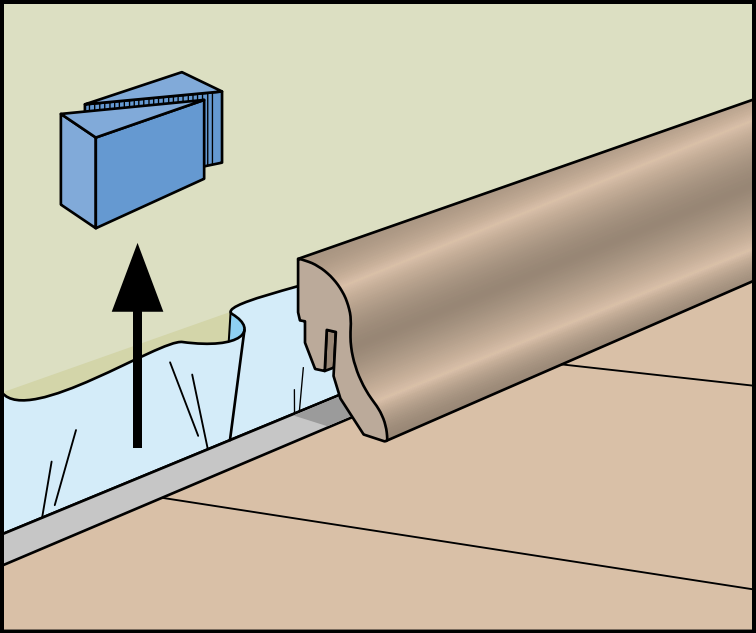



U 50–60%

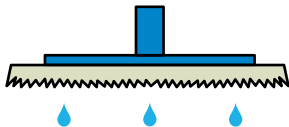
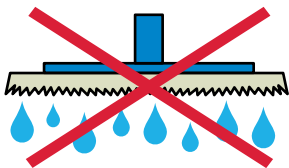
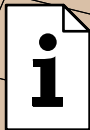
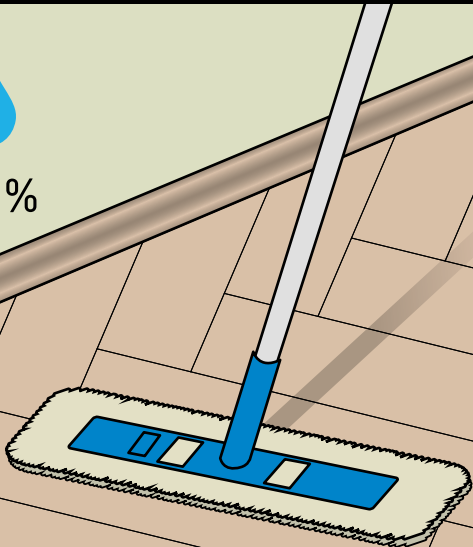

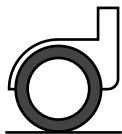
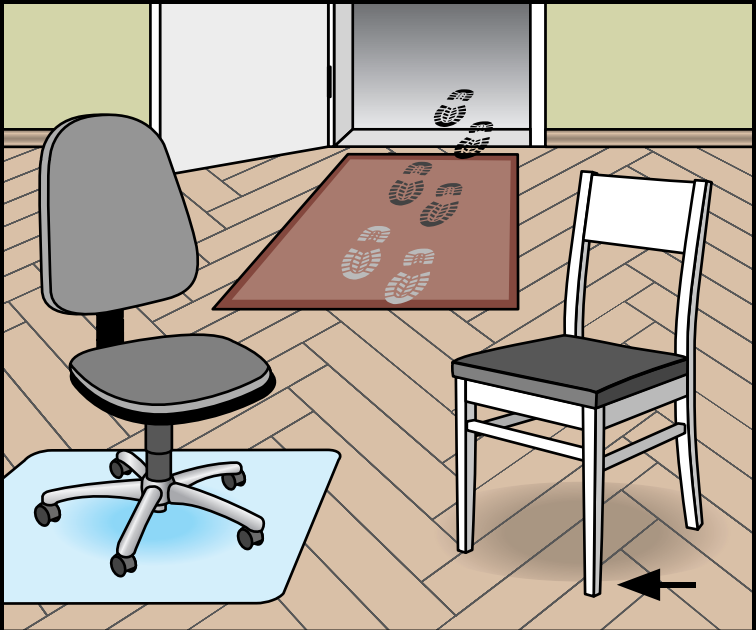

Type »W«
soft / souple
blando / мягкий

