



**COLLECTION 2023**

Made in   
Germany

# About us

KRONOTEX is characterised by innovation, success and international growth. We develop modern, also water-repellent laminate flooring for KRONOTEX. With our design, we set trends for interior design as a global market leader. We produce high-quality, eco-friendly, sustainable, healthy engineered wood materials from debarked domestic pine and spruce wood.

Established in 1992, KRONOTEX is one of the leading European manufacturers of laminate flooring. All KRONOTEX products meet the most rigorous technical and environmental requirements. We have a lengthy tradition of offering customer-focused solutions and adding value for our customers around the world. We naturally strive for an attractive price/performance ratio and high customer satisfaction. We want our products to meet or exceed all of our customer's requirements in terms of usability, healthy living, indoor comfort and environmental friendliness. In order to gain their trust, we practice a strong customer focus and provide competent advice in all of our activities, from sales across service to handling of complaints.

KRONOTEX laminate consists of 90 percent wood from sustainable forestry, is easy to clean, durable and is very easy to lay.



## MAMMUT PLUS

Extra-wide Panels



PANEL 1845 × 244 × 10 mm

BOX 4 panels | 1.800 m<sup>2</sup>

PALLET 42 boxes | 75.600 m<sup>2</sup>

**AC 5  
COMMERCIAL 33\***



Mountain Oak Brown  
1-Strip / ER / 33 AC 5 / V4

D 4726



Macro Oak Hell (light)  
1-Strip / ER / 33 AC 5 / V4

D 4752



Macro Oak Brown  
1-Strip / ER / 33 AC 5 / V4

D 4791



Macro Oak Grey  
1-Strip / ER / 33 AC 5 / V4

D 4792



Macro Oak Nature  
1-Strip / ER / 33 AC 5 / V4

D 4794



Highland Oak Silver  
1-Strip / ER / 33 AC 5 / V4

D4797



Mountain Oak Beige  
1-Strip / ER / 33 AC 5 / V4

D4728



# ROBUSTO

Extremely resilient



PANEL 1375 × 188 × 12 mm

BOX 5 panels | 1.293 m<sup>2</sup>

PALLET 56 boxes | 72.380 m<sup>2</sup>

AC 5  
COMMERCIAL 33\*



Phalsbourg Oak  
1-Strip / MX / 33 AC5 / V4

D 3073

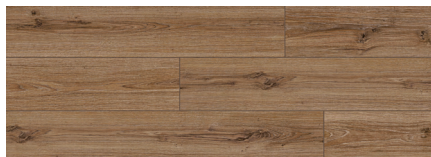

Saverne Oak  
1-Strip / MX / 33 AC5 / V4

D 3074



Timeless Oak  
1-Strip / ER / 33 AC5 / V4

D 3590



Atlas Oak Coffee  
1-Strip / ER / 33 AC5 / V4

D 3591



Atlas Oak Anthracite  
1-Strip / ER / 33 AC5 / V4

D 3592



Adaja Oak  
1-Strip / ML / 33 AC5 / V4

D 4686

# AMAZONE

Extra-narrow panels



PANEL 1380 × 157 × 10 mm

BOX 6 panels | 1.300 m<sup>2</sup>

PALLET 40 boxes | 52.000 m<sup>2</sup>

AC 5  
COMMERCIAL 33\*



Timeless Oak Beige  
1-Strip / ER / 33 AC5 / V4

D 3597



Oak dezent  
1-Strip / AF / 33 AC5 / V4

D 3668



Pettersson Oak dark  
1-Strip / ER / 33 AC5 / V4

D 4766

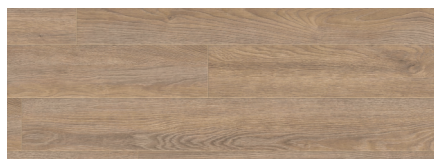

Elbe Oak Nature  
1-Strip / ER / 33 AC5 / V4

D 6014



Prestige oak white  
1-Strip / ER / 33 AC5 / V4

D3239

# MEGA PLUS

Extra-wide in extra design



PANEL 1380 × 326 × 8 mm

BOX 5 panels | 2.249 m<sup>2</sup>

PALLET 45 boxes | 101.223 m<sup>2</sup>

AC 4  
COMMERCIAL 32\*



Concrete  
Natural stone format XL / ST / 32 AC4 / V4

D 4739

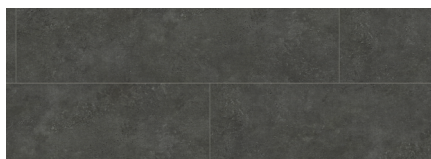

Loft Dark  
Natural stone format XL / BT / V4-MICRO

D 4679

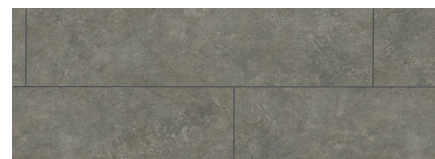

Loft Grey  
Natural stone format XL / BT / V4-MICRO

D 4680

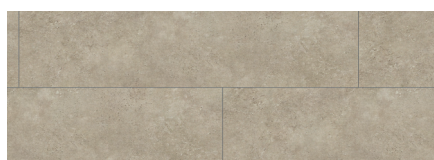

Loft Beige  
Natural stone format XL / BT / V4-MICRO

D 4681

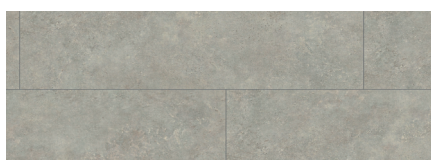

Loft Light  
Natural stone format XL / BT / V4-MICRO

D 4682

# EXQUISIT

Classic floorboard



PANEL 1380 × 193 × 8 mm

BOX 8 panels | 2.131 m<sup>2</sup>

PALLET 56 boxes | 119.320 m<sup>2</sup>

AC 4  
COMMERCIAL 32\*



Stirling Oak  
1-Strip / CP / 32 AC4 / V4 D 2804



Waveless Oak White  
1-Strip / ER / 32 AC4 / V4 D 2873



Waveless Oak Nature  
1-Strip / ER / 32 AC4 / V4 D 3004



Tuscany Walnut  
1-Strip / ER / 32 AC4 / V4 D 3070



Atlas Oak nature  
1-Strip / ER / 32 AC4 / V4 D 3224



Rosemont Oak  
Multi-Strip / AF / 32 AC4 / V4 D 3665



Turin Oak  
1-Strip / AF / 32 AC4 / V4 D 3672



Prestige Oak Nature  
1-Strip / ER / 32 AC4 / V4 D 4166



Nostalgie Teak  
1-Strip / ER / 32 AC4 / V4 D 4170



Sierra Oak Gold  
1-Strip / ML / 32 AC4 / V4 D 4689

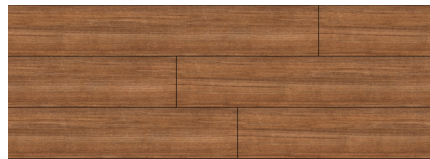

Bali Teak  
1-Strip / AF / 32 AC5 / V4 MV 865

# ADVANCED



PANEL 1380 × 193 × 8 mm

BOX 8 panels | 2.131 m<sup>2</sup>

PALLET 56 boxes | 119.320 m<sup>2</sup>

AC 4  
COMMERCIAL 32\*

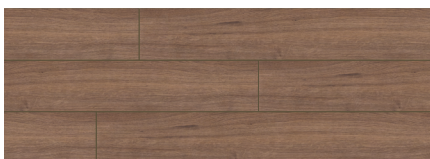

Millennium Oak Brown  
1-Strip / WG / 32 AC4 / V4 D 3531



Summer Oak  
1-Strip / WG / 32 AC4 / V4 D 3901



Summer Oak Beige  
1-Strip / WG / 32 AC4 / V4 D 3902



Century Oak Grey  
1-Strip / WG / 32 AC4 / V4 D 4175



Grand Oak Grey  
1-Strip / WG / 32 AC4 / V4 D 4956



Century Oak Brown  
1-Strip / WG / 32 AC4 / V4 D 4177

# CATWALK



Trend Oak Brown  
1-Strip / WG / 32 AC4 D 3128

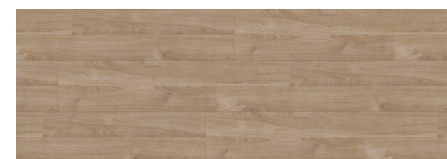

Winter Oak Nature  
2-Strip / WG / 32 AC4 D 5261

# HERRINGBONE

Trendy herringbone design



PANEL 665 × 133 × 8 mm

BOX 14 panels | 1.238 m<sup>2</sup>

PALLET 96 boxes | 118.848 m<sup>2</sup>

AC 4  
COMMERCIAL 32\*



Toulouse Oak  
1-Strip / ER / 32 AC 4 / V4

D 3678



Metz Oak  
1-Strip / ER / 32 AC 4 / V4

D 3766



Oak Silver  
1-Strip / ER / 32 AC 4 / V4

D 3773



Ferrara Oak  
1-Strip / ER / 32 AC 4 / V4

D 3860



Pisa Oak  
1-Strip / ER / 32 AC 4 / V4

D 3861



Calais Oak  
1-Strip / ER / 32 AC 4 / V4

D 4766



# EXQUISIT PLUS

Extra wide boards



PANEL 1380 × 244 × 8 mm

BOX 8 panels | 2.694 m<sup>2</sup>

PALLET 42 boxes | 113.138 m<sup>2</sup>

AC 4  
COMMERCIAL 32\*



Harbour Oak  
1-Strip / ER / 32 AC 4 / V4

D 3570

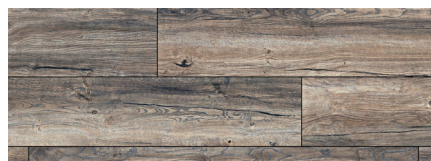

Harbour Oak Grey  
1-Strip / ER / 32 AC 4 / V4

D 3572



Montmelo Oak Toffee  
1-Strip / ER / 32 AC 4 / V4

D 3664



Petterson Oak Nature  
1-Strip / ER / 32 AC 4 / V4

D 4764



Petterson Oak Dark  
1-Strip / ER / 32 AC 4 / V4

D 4766



Elbe Oak Silver  
1-Strip / ER / 32 AC 4 / V4

D 6013



Barcelona Oak  
1-Strip / ER / 32 AC 4 / V4

D 4692



Kashmir Oak Beige  
1-Strip / ER / 32 AC 4 / V4

D 6021

# STANDARD PLUS



PANEL 1380 × 193 × 7 mm

BOX 9 panels | 2.397 m<sup>2</sup>

PALLET 56 boxes | 135.235 m<sup>2</sup>

AC 3  
COMMERCIAL 31\*



Trend Oak Grey  
1-Strip / PR / AC3/31

D 3126



Trend Oak Red  
1-Strip / WG / AC3/31

D 3203



Summer Oak Nature  
1-Strip / PR / AC3/31

D 3903



Finlay Oak  
1-Strip / WG / AC3/31

D 90112



Finlay Oak Nature  
1-Strip / WG / AC3/31

D 90122



Finlay Oak Brown  
1-Strip / WG / AC3/31

D 90142

# STANDARD



PANEL 1376 × 193 × 7 mm

BOX 9 panels | 2.390 m<sup>2</sup>

PALLET 56 boxes | 133.840 m<sup>2</sup>

AC 3  
COMMERCIAL 31\*



Beech Nobel  
3-Strip / PR / AC3/31

D 1424



Autum Oak Nature  
3-Strip / PR / AC3/31

D 4951



Winter Oak Grey  
2-Strip / PR / AC3/31

D 5262



Autumn Oak  
3-Strip / PR / AC3/31

D 4953



# SKIRTING BOARDS



KTEX1



Accessories for KTEX1

1-Exterior corner piece (EP)  
2-Interior corner piece (IP)  
3-End cap (EC)  
Economy pack - 1 Packet - 2 x EP + 6 x IP + 2 x EC

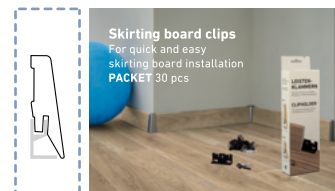

Skirting board clips

For quick and easy  
skirting board installation  
PACKET 30 pcs

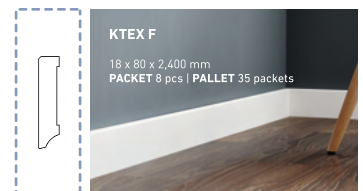

KTEX F

18 x 80 x 2,400 mm  
PACKET 8 pcs | PALLET 35 packets



KTEX P

MDF, white, proled, can be painted  
18 | 80 | 2,400 mm  
PACKET 8 pcs | PALLET 35 packets



Corner piece for KTEX F and KTEX P

22 | 22 | 82 mm  
PACKET 2 pcs  
Available in white decor.



AQUA 80

white  
19 | 80 | 2,500 mm  
PACKET 6 pcs | PALLET 30 packets



PREMIUM SOUND

PU-based with foil lamination  
8,500 | 1,000 | 1,8 mm  
1 packet 1 roll = 8.5 m<sup>2</sup>  
1 pallet 40 rolls

# ALUMINIUM PROFILES

## Transition Profile

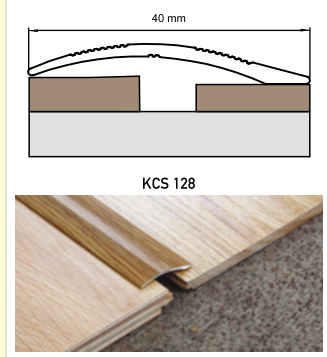
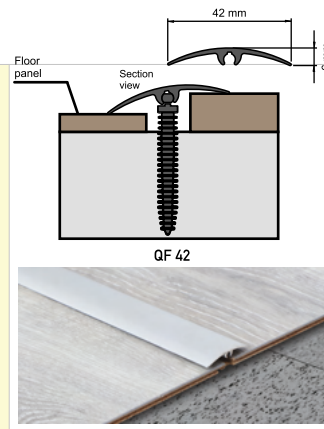
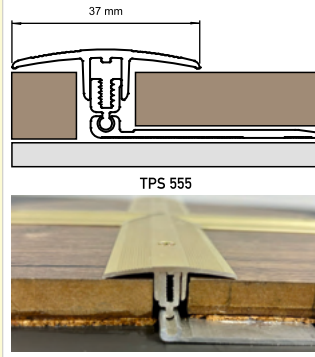

## Skirting

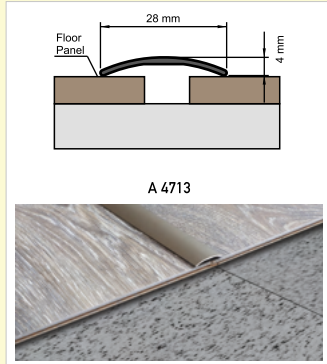
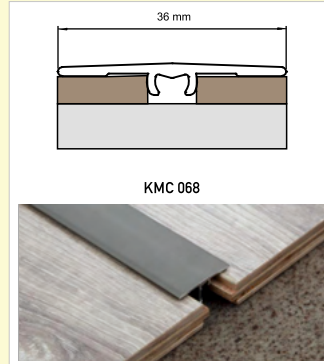
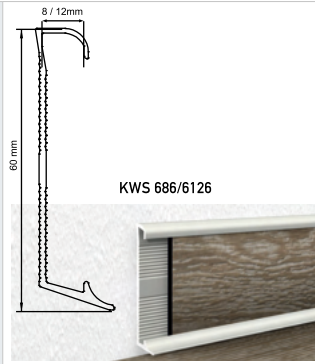

## Stair Nose

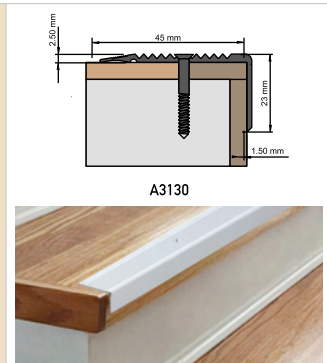
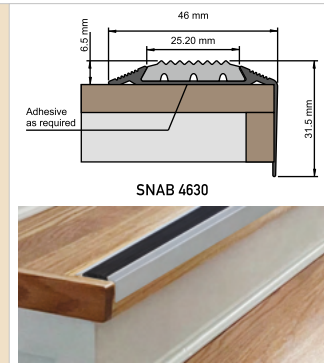

## End Profile

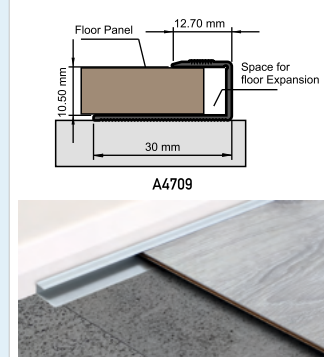
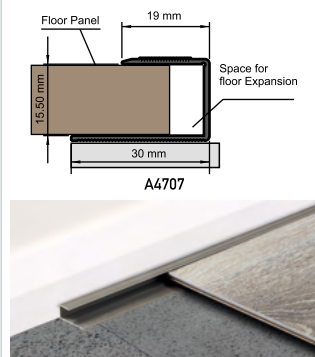

## Carpet Profile

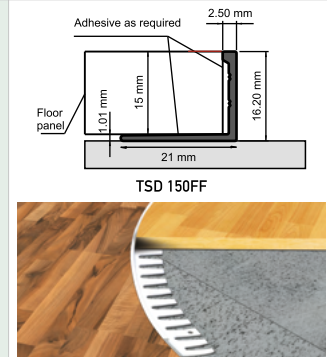
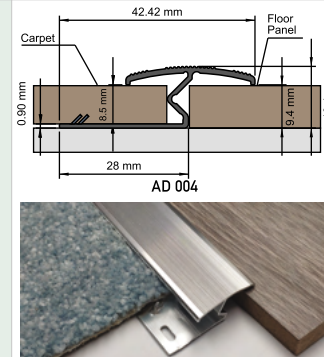
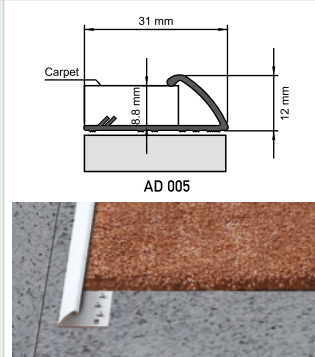

# SURFACES

## EXPLANATIONS

1-Strip (country house)



2-Strip

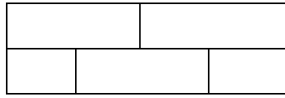

3-Strip

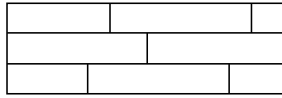

Multi-Strip

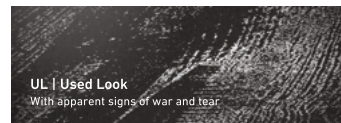
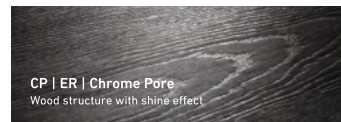
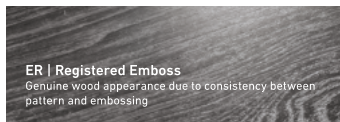
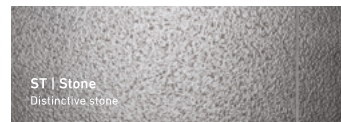
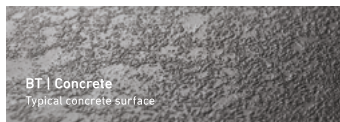
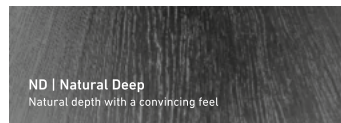
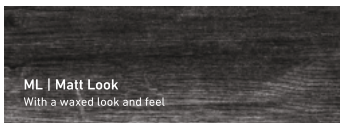
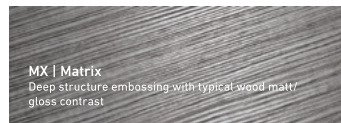
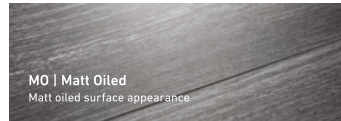
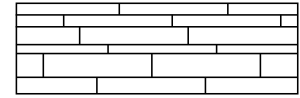

**KRONOTEX LAMINATE FLOORING (INDIA) PVT.LTD.**

**Corporate Office :-**

U19A, Upwan Welfare Society, New Palam Vihar  
Sector 109, Gurugram -122017, Haryana

**Branch Office :-**

Shed No. 24/1B, Doddakallasandra, Bengaluru,  
Karnataka, 560062

[www.kronotex.in](http://www.kronotex.in)

